



## USG BORAL HOOK-ON™ CEILING SYSTEM

### Technical Manual (Installation Guide)

The USG Boral Hook-on™ Ceiling System adds a clean and smooth visual appearance to any space for a modern look. The ceiling panels are available in multiple sizes. They can be easily installed or uninstalled separately, granting convenient access to the plenum.



[USGBoral.com](http://USGBoral.com)

Gypsum Boards

Ceilings

Compounds

Metal Framing

Substrates

# USG BORAL HOOK-ON™ CEILING SYSTEM

## Safety First!

Follow good safety and industrial hygiene practices during installation. Wear appropriate personal protective equipment.

## Installation

All ceiling products and systems must be installed and maintained in accordance with current USG Boral written instructions and best industry practice, including the CISCA Handbook, ASTM C636, and standard industry practices, within all applicable code requirements. Alternative assemblies and installation methods may be utilised when approved by the Authority Having Jurisdiction. USG Boral recommends checking with the Authority Having Jurisdiction prior to designing and installing a suspended ceiling system. Because codes continue to evolve, check with a local official prior to designing and installing a ceiling system. Other restrictions and exemptions may apply.

## Notice

We shall not be liable for incidental and consequential damages, directly or indirectly sustained, nor for any loss caused by application of these goods not in accordance with current printed instructions or for other than the intended use. Our liability is expressly limited to replacement of defective goods. Any claim shall be deemed waived unless made in writing to us within thirty (30) days from date it was or reasonably should have been discovered.

### System Components - Supplied by USG Boral

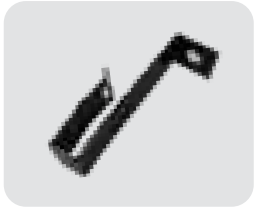

C-channel bracket

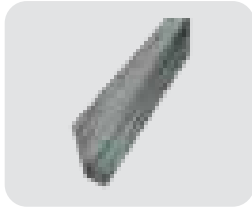

C-channel

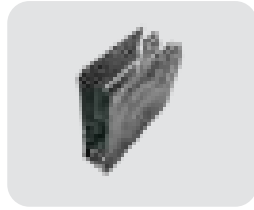

Z-runner bracket

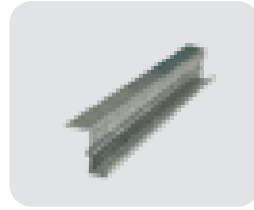

Z-runner

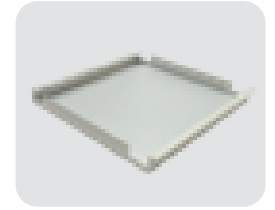

Hook-on panel



Runner connector

### System Components - Supplied by Installer

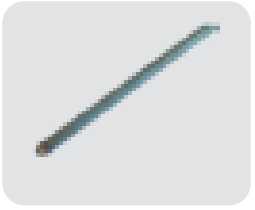

Galvanised M6 threaded rod



Galvanised M6 nut

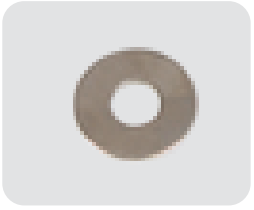

Galvanised M6 washer



Galvanised M6 self tapping screw

### Tools Required for Installation



Cordless drill/driver

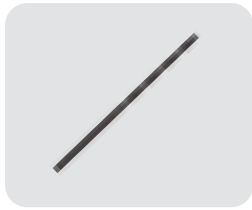

6mm black oxide coated drill bit



6mm rotary masonry drill bit



Phillips head #2 screwdriver bit

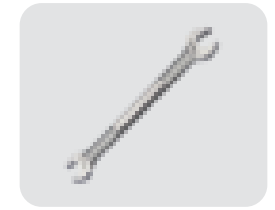

10mm open ended wrench



Safety glasses

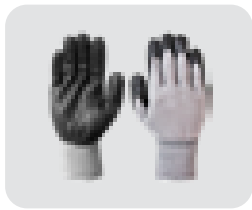

Work gloves



Safety helmet

## General Arrangement Drawing of Suspension System

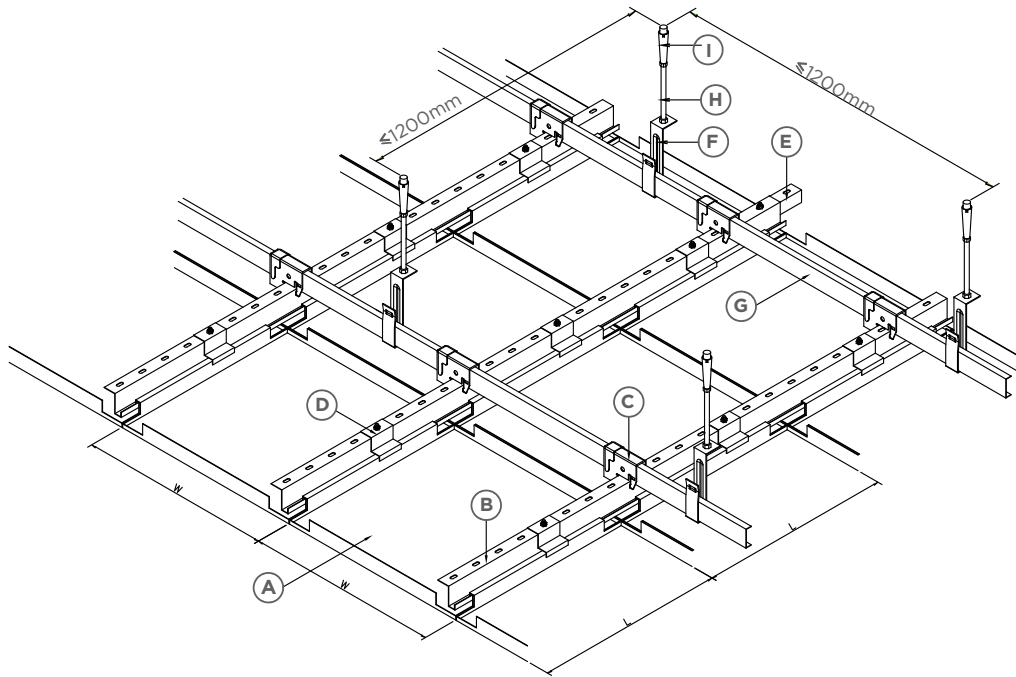

Item	Description
A	Hook-on panel
B	Z-runner
C	Z-runner bracket
D	Security clip
E	Runner connector
F	C-channel bracket
G	C-channel
H	Threaded rod
I	Anchor bolt

## Step by Step Installation Instructions



### Step 1

Put on personal protective equipment.



### Step 2

Ensure M6 threaded rod is securely mounted to the concrete ceiling. Insert M6 nut for C-channel bracket.

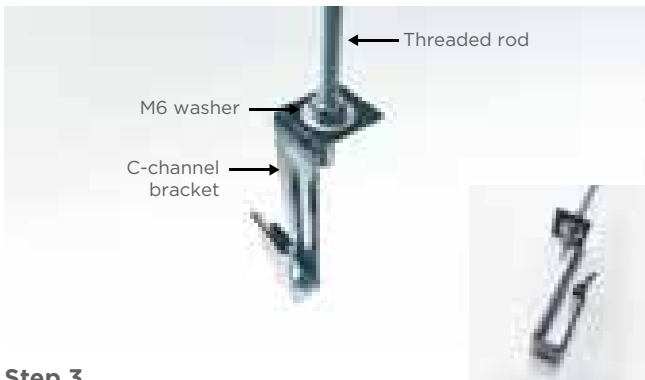

### Step 3

Insert C-channel bracket. Secure with M6 washer and nut on the top and bottom of the bracket as shown.

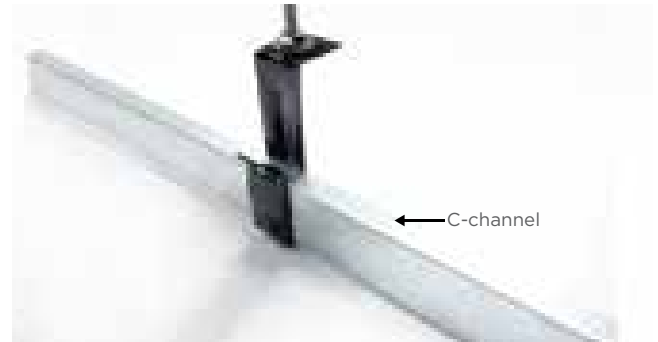

### Step 4

Insert C-channel into C-channel bracket. Ensure C-channel and C-channel bracket are both level.

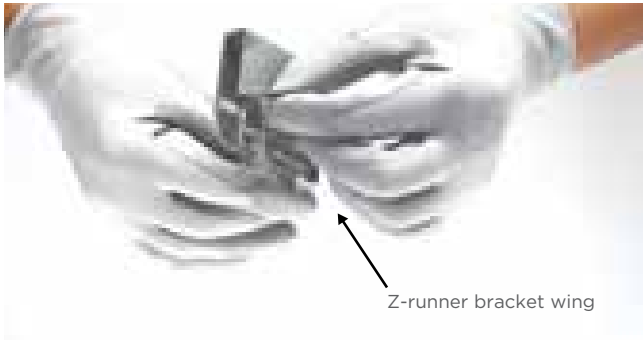

**Step 5**

Bend both wings of Z-runner bracket out far enough for the Z-runner to slide into the bracket.



**Step 6**

Install the Z-runner bracket onto the C-channel and slide Z-runner into the bracket. Secure Z-runner bracket to C-channel with a M6 self tapping screw.



**Step 7**

Ensure Z-runner and C-channel are both level.



**Step 8**

Fold the wings of the Z-runner bracket back to its original position.



**Step 9**

Install a Hook-on panel onto the Z-runner.

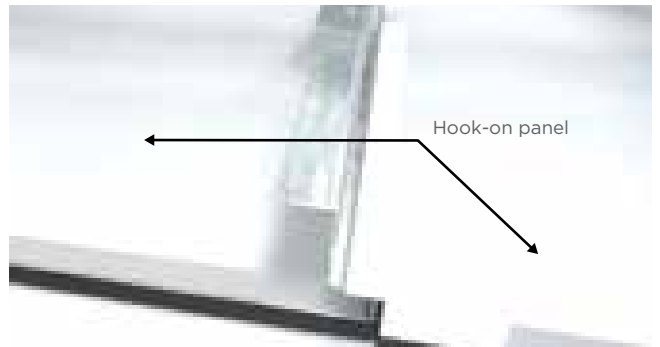

**Step 10**

Install remaining Hook-on panels in accordance with the ceiling layout.

Australia  
China  
India  
Indonesia  
Malaysia  
Middle East  
New Zealand  
**Philippines**  
Singapore  
South Korea  
Thailand  
Vietnam

3rd Floor 108 Central Building A  
108 E. Rodriguez Jr. Avenue, Bagumbayan,  
Quezon City, Philippines 1110  
T: +63 2 911 6709 | F: +63 2 911 6709 ext. \*98  
[info.ph@usgboral.com](mailto:info.ph@usgboral.com)